

FRONT VIEW

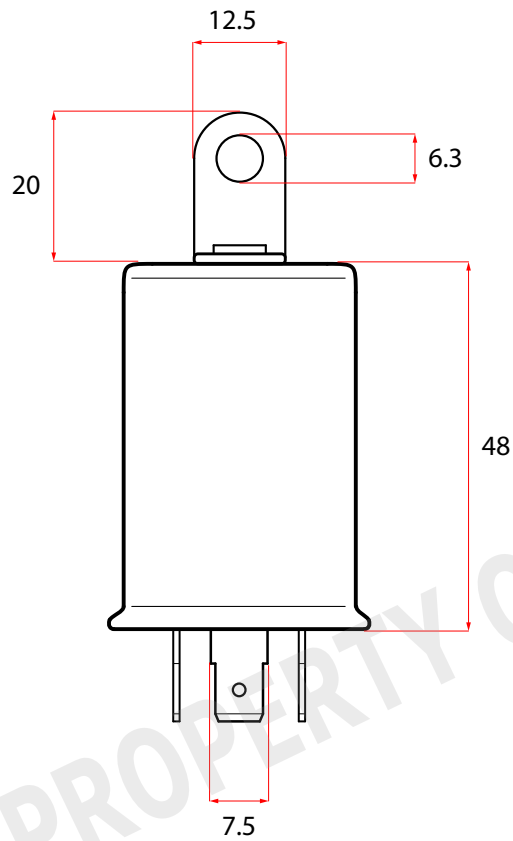

SIDE VIEW

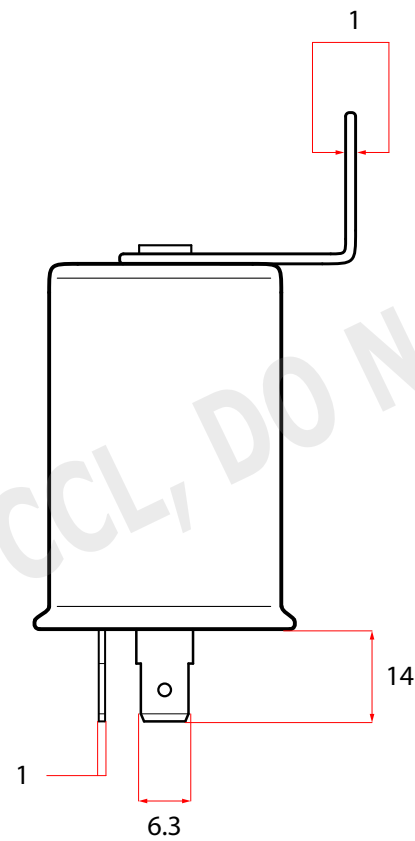

TOP VIEW

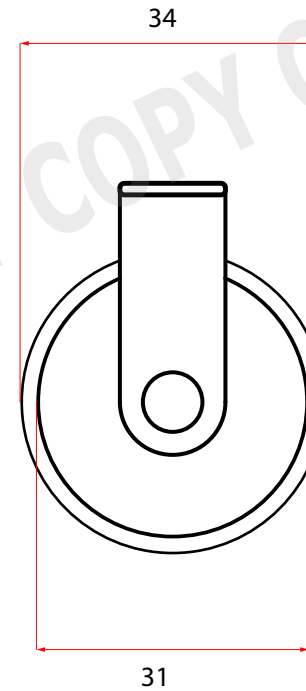

PIN LAYOUT

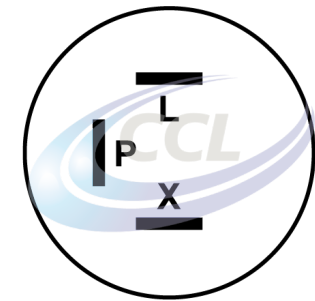

+ / - 5% All Dimensions In MM

Part Number	01-008H
Type	Thermal
Voltage	24V
Side Repeater Lamps	2 x 5W
Indicator Lamps	4 x 21W
Max Load	94W
Function	Hazard Only
Bulb Failure Indicator	No

Bracket Type	Fixed Metal
---------------------	-------------



Marlborough Works, Marlborough Road, Accrington, BB5 5BE
 Tel: +44 (0) 1254 300 730 Fax: +44 (0) 1254 237432
 e-mail: sales@currentcare.co.uk

© Copyright CurrentCare Ltd 2016

All Measurements And Specifications Are Accurate + / - 5%
 Some Specifications May Vary / Change Without Prior Notice